

# Capacitance

•What is it?  $C=Q/V$   $Q=CV$   $W=Q^2/2C$

measure of how much charge can be stored at fixed potential  
or how much energy can be stored

frequently used - sampling, ADC,...

generalise (1st year electrostatics) - system of conductors

potentials  $U_j$  charges  $Q_j$   $Q_i = \sum_j c_{ij} U_j$   $W_i = (1/2) \sum_j c_{ij} U_i U_j$

Capacitance in a multi-electrode system not defined by single number.

but we encounter many components which appear to conform

Consider most elementary example: parallel plate capacitor

$$E = V/d = \sigma/\epsilon_0 = Q/A$$

apply Gauss' law  $C = Q/V = \epsilon_0 A/d$

put charge  $+Q$  on plate 1,  
induce charge  $-Q$  on plate 2 with ground connection

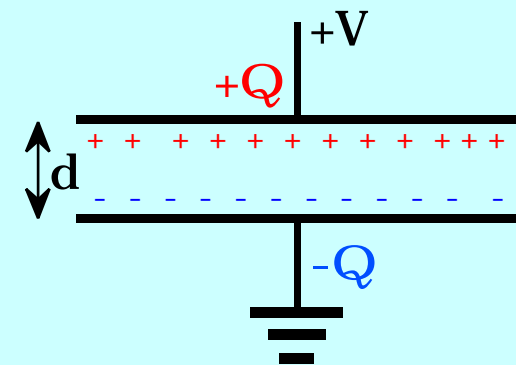

•Is life really so simple?

## Capacitance (2)

- **More realistic situation - capacitor near to other surfaces**

eg in box, likely to be grounded for safety  
some induced charge likely to end up on box

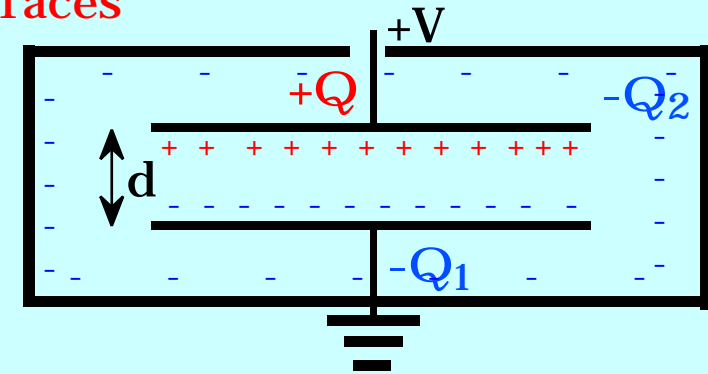

- **Even more realistic case segmented detector**

*typical of many ionisation detectors (strips, pads, multiwire)*

capacitance of strip made up of several contributions

*C to near neighbours*

*C to next nearest...*

*C to opposite surface*

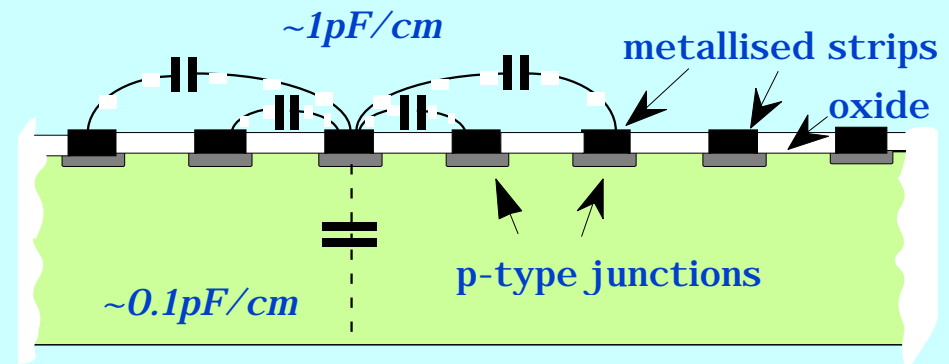

In physical terms

*put small charge on electrode - disturb system a small amount*

*all other charges in system rearrange themselves (according to EM laws)*

*coefficients of capacitance are measure of this*

## Capacitance (3)

---

- why is this important?

many situations - working with small signals

*will need care to measure them*

many modern situations - working with high speed signals (high  $f$ )

*eg. modern optical communication links  $\gg Gb/s$*

$$Z_c = 1 / C = 1/2 fC$$

$$f \gg 10^9 \text{ Hz}$$

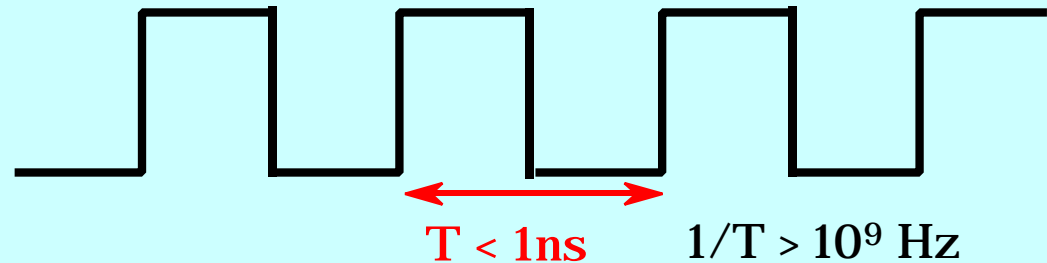

- “small signal” capacitance

in many circumstances,  $C = dQ/dV$  is a more appropriate definition

$C$  can be a function of  $f$  - eg semiconductor devices

- what magnitudes of capacitance can we expect to encounter?

# Cylindrical cable

- Simplest design - long wire ( $r=a$ ), with surrounding conducting cylinder ( $r=b$ )

this is easy to calculate

= charge per unit length of wire

- Gauss' law

$$\mathbf{E} \cdot \mathbf{n} \cdot d\mathbf{S} = \dots$$

$$E(r) = \dots / 2 \quad r = -d / dr$$

apply boundary conditions

$$V = (\dots / 2) \ln(b/a)$$

$$C = Q/V = 2 \dots / \ln(b/a) = \text{capacitance per unit length}$$

eg.  $2.3 \epsilon_0$   $a = 0.5\text{mm}$   $b = 2\text{mm}$   $C = 1 \text{ pF.cm}^{-1}$

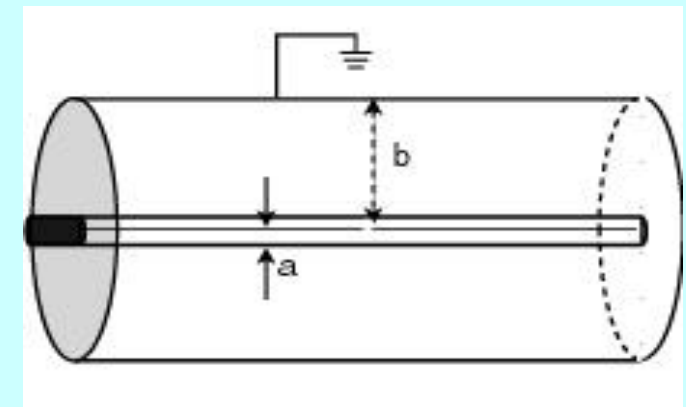
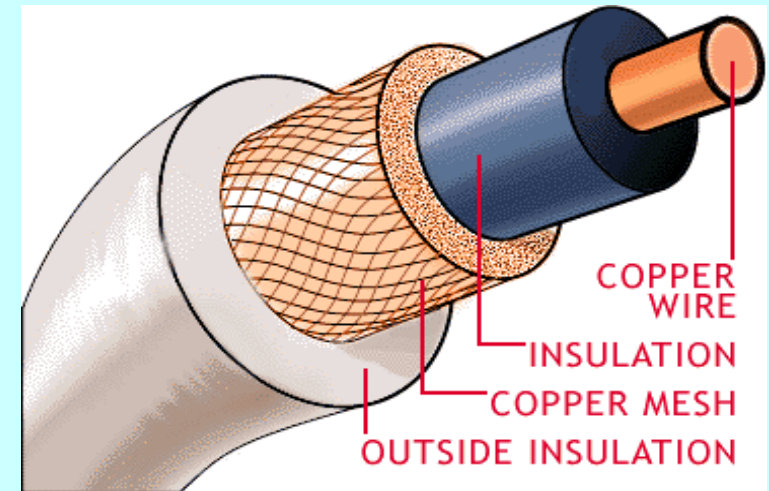

# Inductance

---

- arises from magnetic effects, also giving rise to frequency dependent impedance

- Definition Faraday's law**

EMF = potential difference =  $-d(\text{flux})/d(\text{time})$

magnetic flux =  $\int_S \mathbf{B} \cdot \mathbf{n} \, dS$

- Inductance defined**  $L = d(\text{flux}) / d(\text{current}) = d \ / dI$

so L is a measure of change of magnetic flux in response to change in current

$$d \ = LdI$$

real systems likely to involve flux changes which depend on several components in the system

*except for transformers less likely to concern us*

## Inductance (2)

- **Example thin wire with current I**

Ampere's law

$$\oint_c (\mathbf{B} \cdot d\mathbf{l}) = \mu_0 I = B \cdot 2\pi r \quad \text{around circuit}$$

: consider area at  $r$ , dimensions  $z \times dr$

$$d\Phi = B \cdot z \cdot dr = \mu_0 I z \cdot dr / 2\pi r$$

- **integrate, with limits  $a < r < b$**

$$d\Phi = B \cdot z \cdot dr = (\mu_0 I z / 2\pi) \ln(b/a)$$

$$L = (\mu_0 z / 2\pi) \ln(b/a)$$

eg.  $a = 0.5\text{mm}$   $b = 2\text{mm}$   $L = 2.8 \text{ nH.cm}^{-1}$

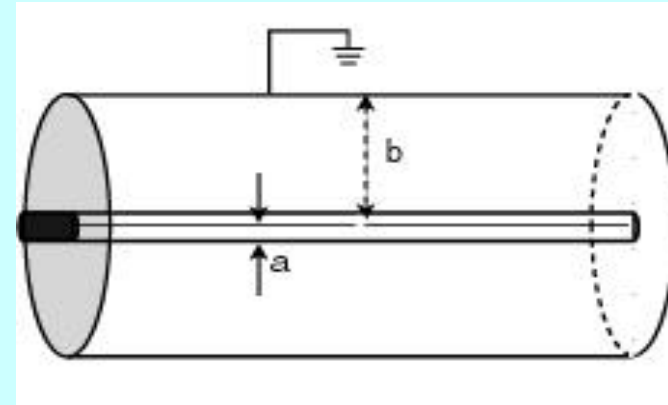

## Inductance (3)

• why is it important?  $V = -L \frac{dI}{dt}$

transient effects

*sudden change in current in a long cable could generate large voltage spike*

time varying signals  $I = I_0 e^{j\omega t}$   $\omega = 2\pi f$

$$V = j\omega L I = Z_L I$$

impedance  $Z = j\omega L$

NB sign positive because applied voltage moved to right side of equation

$$V_{\text{battery}} - L \frac{dI}{dt} = IR + I \frac{dQ}{dt} / C$$

$$V_{\text{applied}} = IR + I \frac{dQ}{dt} / C + L \frac{dI}{dt}$$

$$v = iR + i/j\omega C + j\omega L i \quad v = V_0 e^{j\omega t}$$

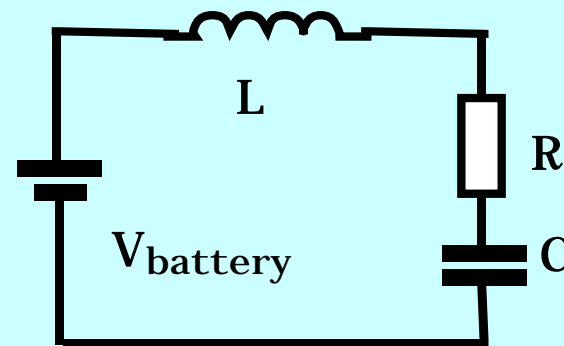

# Equivalent circuits

---

- Real instruments and devices quite complex

but usually need to simplify to understand behaviour & influence

Equivalent circuit represents major properties

often useful to consider voltage generator or source + series impedance

or current source + parallel impedance

Impedances not usually simple resistances - frequency dependent

- Calculate using two important theorems

Thevenin            voltage

Norton             current

- first recall how to analyse circuits...



# Kirchoff's laws

---

- sum of currents into point = sum of currents out
- sum of voltage drops around closed circuit = 0

- Thevenin's theorem

any two terminal network or resistors and voltage sources is equivalent to single resistor  $R_{th}$  in series with voltage source  $V_{th}$

$$R_{th} = V_{open}/I_{short} \quad V_{th} = V_{open}$$

eg voltage divider

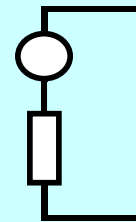

can generalise to more complex impedances

- Norton's theorem

...network equivalent to ...  $R_n$  in parallel with current source  $I_n$

$$I_n = I_{short} \quad R_n = V_{open}/I_{short}$$

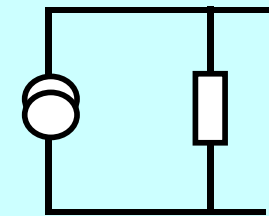

# Earth or ground

---

- **Very important concept in instrumentation applications**

represents infinite reservoir of electric charge, always capable of receiving electric flux (field) from any charged body

“earth” - best earth connection is solid & substantial connection to ground  
*deep Cu stake embedded in moist soil*

In practice few grounds so substantial  
*eg consider path to ground pin on oscilloscope (or kettle!)  
tenuous path with current carrying cables nearby  
plenty of chance for induced currents*

- **Important consequences to be considered later...**

# Jargon, names & concepts

---

- **Linear systems** *will be a frequent assumption*

input signal =  $f(t)$    output =  $g(t)$

expect output to vary with input as  $Af(t) \rightarrow Ag(t)$

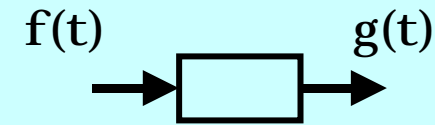

not always the case, eg amplifiers frequently exhibit saturation

*can arise for several reasons*

constraints in amplifier design

*if 0-5V power, don't expect output signals over full 5V ( and none >5V!)*

deliberate design choice to measure signals with precision depending on size

*eg relative precision often required*

- **Superposition**

important principle in many areas of physics & mathematical physics

If  $f_1(t) \rightarrow g_1(t)$    and  $f_2(t) \rightarrow g_2(t)$

then  $af_1(t) + bf_2(t) \rightarrow ag_1(t) + bg_2(t)$

# Saturation example

- An example of a real amplifier

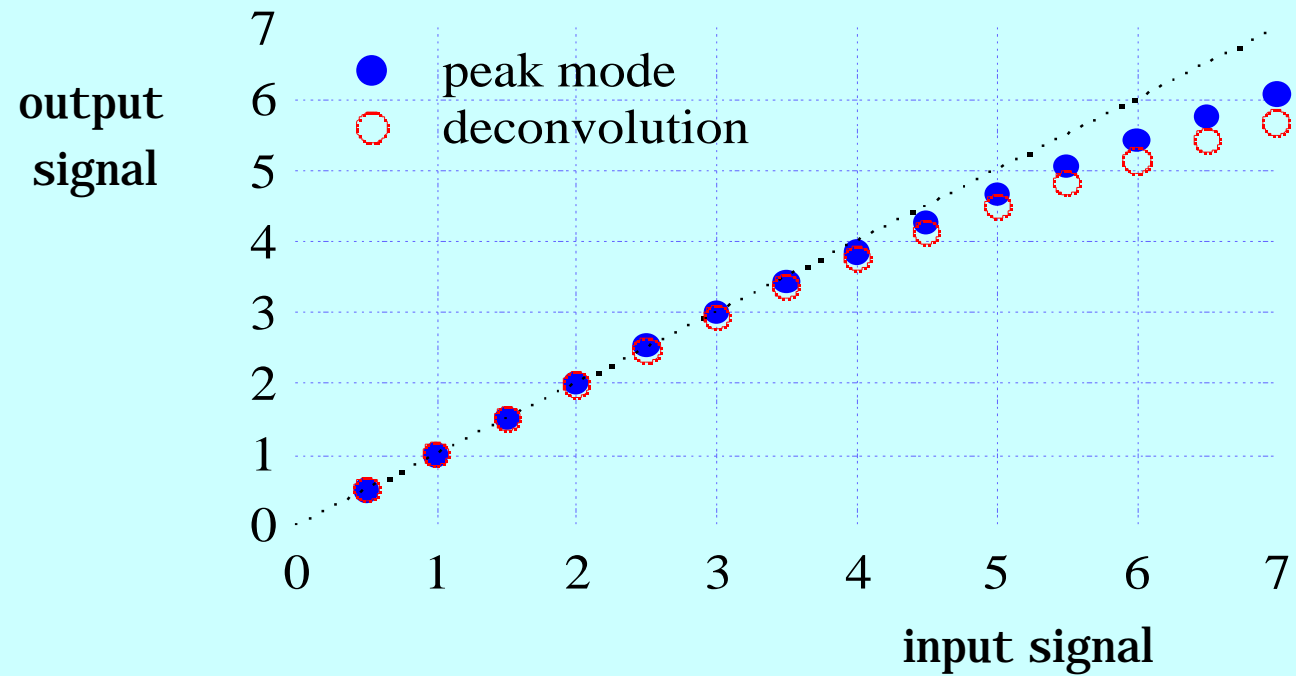

# Decibels

---

- decibels (dB)

signal magnitudes cover wide range so frequently prefer logarithmic scale

Number of dB =  $10\log_{10}(P_2/P_1)$

often measuring voltages in system: dB =  $20\log_{10}(V_2/V_1)$

- Not an absolute unit and sometimes encounter variants

dBm: dB with  $P_{in} = 1\text{mW}$

# Dynamic range

---

- **In most systems there will be a smallest measurable signal**

if there is noise present, it is most likely to be related to the smallest signal distinguishable from noise

*3 x rms noise? 5 x rms noise?*

or quantisation unit in measurement

- **and a largest measurable signal**

most likely set by apparatus or instrument, eg saturation

- **Dynamic range = ratio of largest to smallest signal**

often expressed in dB or bits

eg 8 bits = dynamic range is  $256_{10}$   
= 48dB (if signal is voltage)

# Precision

---

- many measurements involve detection of particle or radiation quantum (photon)

simple presence or absence sometimes sufficient = binary (0 or 1)

other measurements are of energy

- why do we need such observations?

primary measurement may be energy

*eg medical imaging using gammas or high energy x-rays, astro-particle physics*

extra information to improve data quality

*removes experimental background, eg Compton scattered photons mistaken for real signal*

optical communications - constant pressure to increase “bandwidth” - eg number of telephone calls carried per optical fibre

*wavelength division multiplexing - several “colours” or wavelengths in same fibre simultaneously*

*require wavelength sensitive sensor to distinguish different signals*

- what is ultimate limit to precision?

# Statistical limit to energy measurement

- **Assume no limit from anything other than sensor**

*often not realistic assumption, but best possible case*

$$N_{\text{quanta observed}} = E /$$

= energy deposited by radiation

---

energy required to generate quantum of measurement

examples

*semiconductor: energy for electron-hole pair ~ few eV*

*gaseous ionisation detector: energy for electron-ion ~ few x 10 eV*

*scintillation sensor: energy per photon of scintillation light ~ 100 eV*

- **Basic Poisson statistics**

$$E_{\text{meas}} \sim N_q$$

$$\sigma^2(N_q) = N_q$$

$$\sigma(E)/E = \sigma(N_q)/N_q = 1/\sqrt{N_q}$$

*expect gaussian distribution of  $N_q$  for large  $N_q$*

advantage in sensor with small

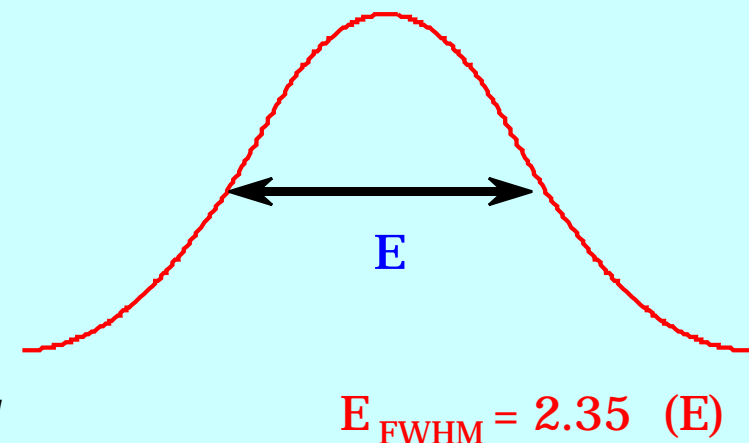



# Time invariant systems

- many systems respond so that output depends only on time of application  
ie later application of same signal results in delayed, but identical, output

If  $f(t) \rightarrow g(t)$  then  $f(t+t_0) \rightarrow g(t+t_0)$

seems trivial but many counter examples  
e.g sampled signals

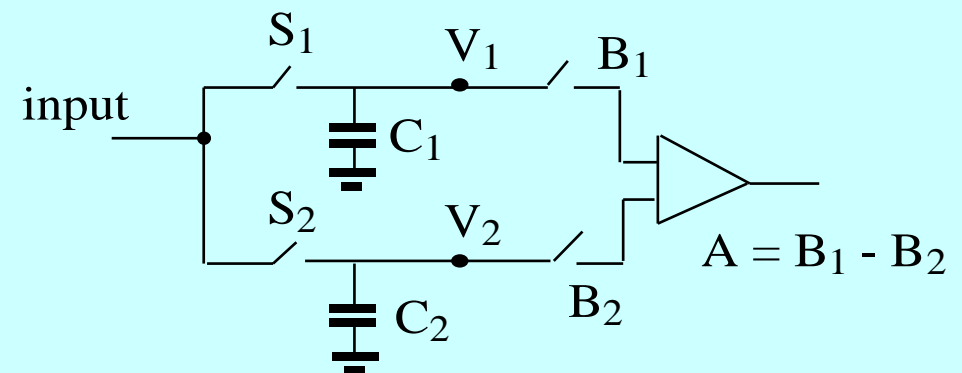
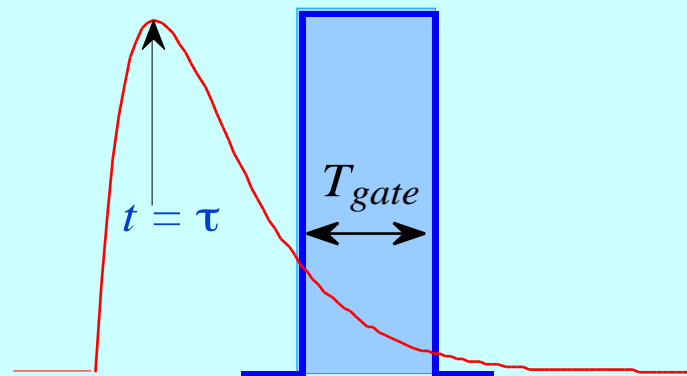
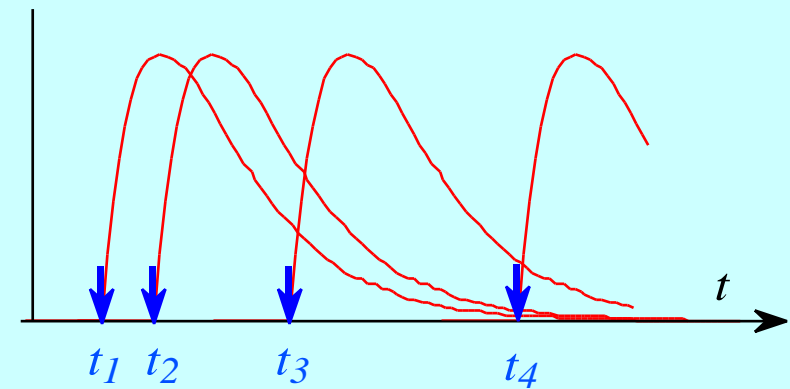

examples of time variant systems

# Filters

- Device or components to transform electrical signals from one form to another

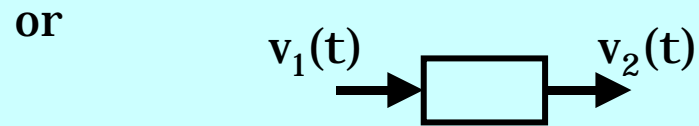
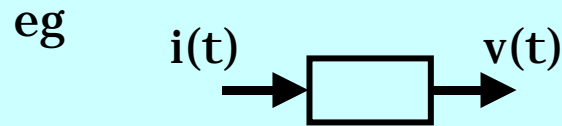

usually when doing so, amplitudes of frequencies in output are different from those input,

*ie spectral content is changed or some frequencies filtered out*

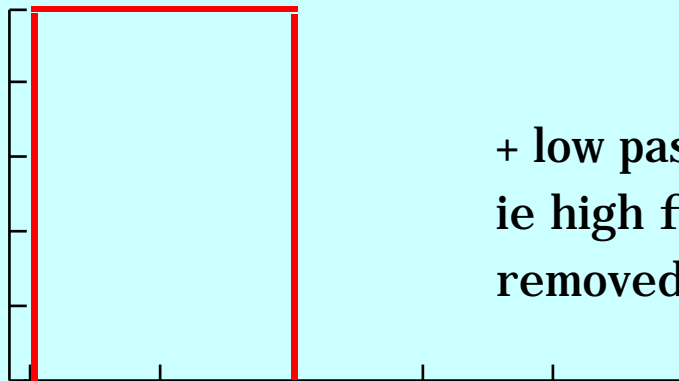

+ low pass filter  
ie high frequencies  
removed

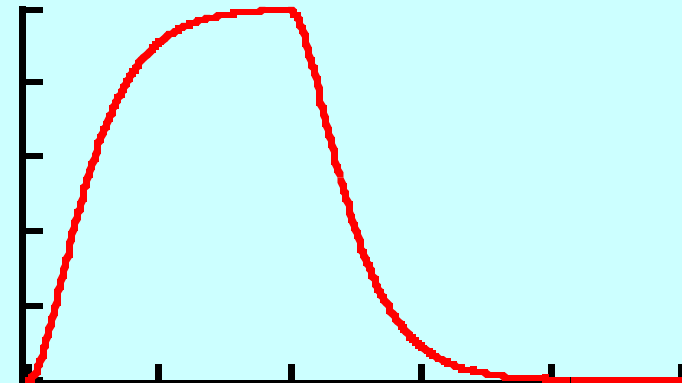

frequently want to analyse signals and systems in terms of frequency content, as well as behaviour in time

# Transfer Function

- Inputs to, and outputs from, system considered as sum of components, with each component a single frequency

$$F(\omega) = A(\omega) e^{j\omega t}$$
$$= 2 \cos \omega t$$

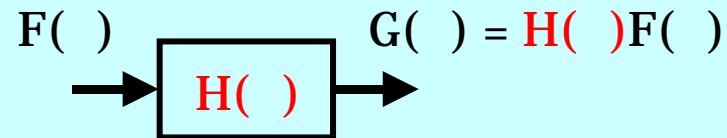

$H(\omega)$  is transfer function of system =  $G(\omega)/F(\omega)$

generally complex so introduces both **phase** and **amplitude** changes

Eg high pass filter  $H(\omega) = v_{\text{out}}(\omega)/v_{\text{in}}(\omega)$

characteristic frequency referred to as **pole**

$$f = 1/2\pi RC = 1/2\pi RC$$

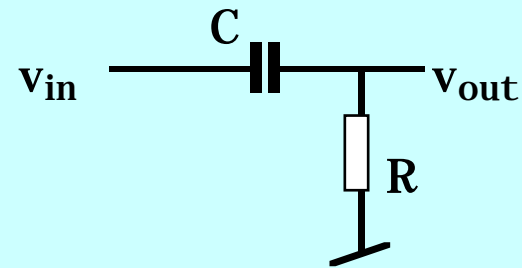

*We will find the Fourier (or Laplace) transform an important tool for handling this kind of thing*

# High and low pass filters

## •High pass filter

$$H(\omega) = R / (R + 1/j\omega C)$$
$$= j\omega RC / (1 + j\omega RC)$$

$$\tau = RC$$

response to voltage **step**  $\sim e^{-t/\tau}$

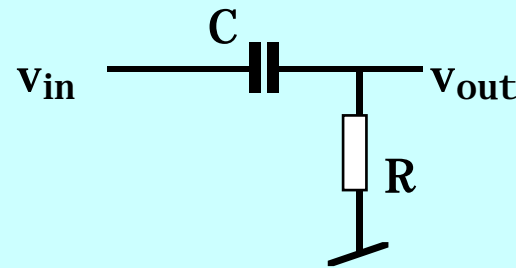

## •Low pass filter

$$H(\omega) = (1/j\omega C) / (R + 1/j\omega C)$$
$$= 1 / (1 + j\omega RC)$$

"roll-off" 6dB/octave at high frequencies

response to voltage **step**  $\sim 1 - e^{-t/\tau}$

rise time: usually define as 10-90%

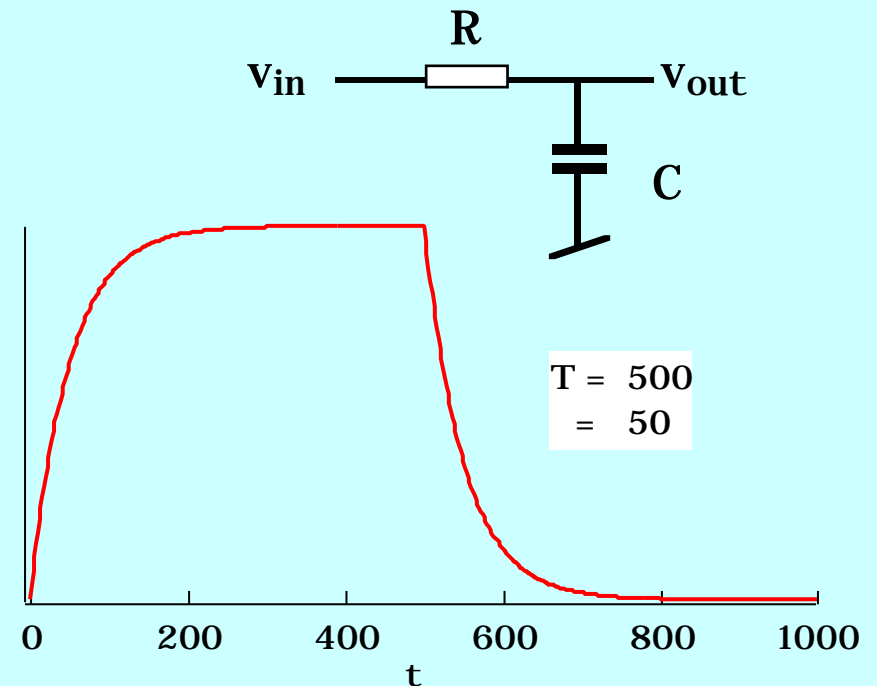

# Frequency behaviour

## •Bode plot

display transfer function of a circuit as function of frequency

$$H(f) = |H(f)|e^{j\phi}$$
$$= \text{Re}[H(f)] + j\text{Im}[H(f)]$$

*Usual to plot gain on log-log scale and phase vs log f*

## •3db point

frequency at which power is half maximum

$$\text{voltage} = x 1/\sqrt{2}$$

## •High frequency behaviour

low pass filter  $H \sim 1/f$   
*-20dB for each f decade*  
*(-6dB per octave)*

