

Extrinsic noise

- or Why Things Don't Always Work

even though you thought you'd done everything right

Practical instrument systems composed of electrical components

define geometry of potentials and electric fields in system

measurement of charge \Leftrightarrow rearrangement of potentials in system

ie current flows

- we can't take the current paths for granted - why?

already know that electrostatic (capacitive) and magnetic (inductive) connections are present between components - as well as simple conductive connections

so usually there are several routes along which current can flow, especially depending on frequency range covered by instrument

- we need to plan them

Simple example

- Thunderstorm

dramatic movement of charges with obvious consequences

but even at some distance from lightning strike, observe induced and conductive current flows

frequent source of damage to electronics

fax machines, modems, telephones,..

Sources of pickup

- Lights

typically ~50Hz but...

- Power supplies - in almost all apparatus!

50Hz "hum" - often transformers

Switched mode: AC rectified -> DC -> DC chopped -> square wave (~kHz)

uses capacitors and diodes to generate high(er) voltages - eg kV for TV

- RF pickup

capacitive coupling of high frequencies from...

... computers, radio or TV, mobile phones,...

... digital logic inside system

- Microphonics

surface vibrations of metal surface, cause capacitance variations

motors, vacuum pumps, transformers, ...

How to find noise sources

- Lights

Do I need to say?

- 50Hz mains and higher frequencies

analogue oscilloscope, varying time base and trigger

- RF

analogue scope

spectrum analysis

can sometimes be misleading without experience

- Varying conditions, eg ground connections

sometimes hard to avoid in practice

but not the best way of improving things, especially if hit-or-miss

- How to avoid or eliminate extrinsic noise?

Shielding

- place sensitive amplifier- detector in metal enclosure

 - external E field lines terminate on surface

Incident EM waves reflected

$$E_{\text{ref}}/E_{\text{inc}} = (1 - Z/Z_0) \quad Z_0 = (\mu_0/\epsilon_0)^{1/2} = 377$$

Absorbed wave limited to skin depth

$$\sim e^{-x/\delta} \quad \delta = (2/\mu \sigma)^{1/2}$$

Al: $\sim 100\mu\text{m}$ at 1MHz

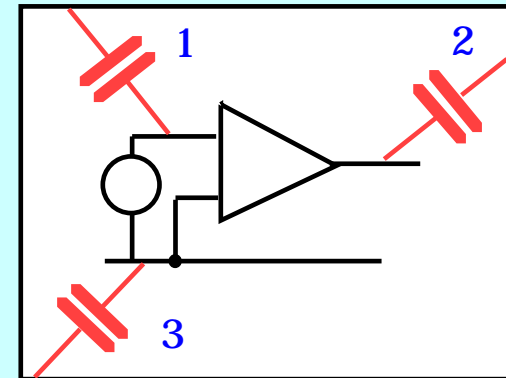

- Potential problems

 - capacitances to shield - feedback

shield connection

how to get signals in and out?

try to make tight connections

with low resistance

E field can penetrate gaps \ll

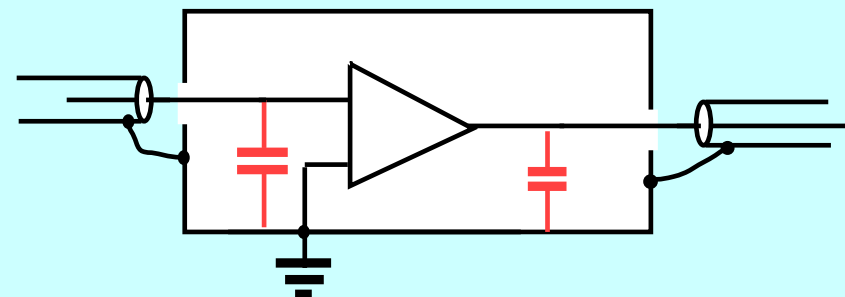
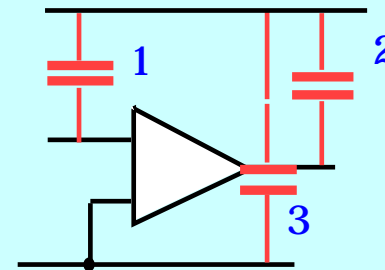

Ground loops

- Real amplifiers have more than 3 terminals

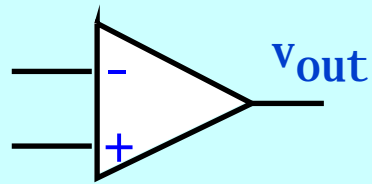

Inputs draw no current but output provides current
- where does it go?

- Route for output current

does it flow where it should?

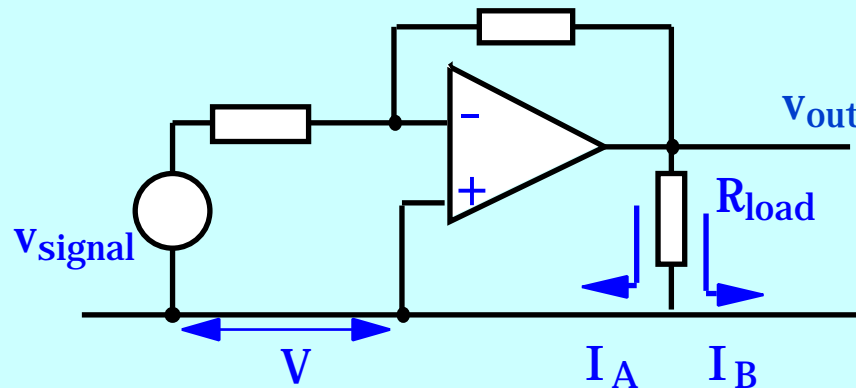

$$V_{out} \gg V_{signal}$$

I large

R in line \rightarrow V

- If current flows in reference line (usually ground) expect voltage drops
ie ground is not 0V everywhere - even if circuit diagram assumes so
ensure large currents, especially later amplifier stages, provided separately

Inductive and conductive paths

- **Inductive paths**

Long paths can form loops in which other currents flow
currents => changing magnetic field

B induces current noise

Avoid with balanced signals, flowing in closely spaced conductors

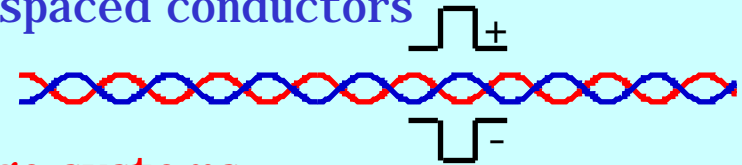

- **May still be difficult to implement in remote, large systems**

optical data transmission can remove a large part of loop

- **Routing noise out of sensitive locations**

large capacitors to ground, or DC point

at frequencies where $C \gg 1$, noise sees low impedance path to ground

Other solutions

- **Differential transmission and receivers**

same noise appears on both lines

can subtract common mode signals

at expense of loss of some dynamic range, eg...

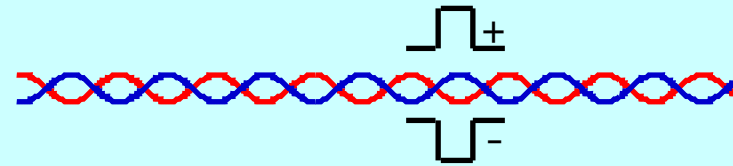

- **Battery power**

eliminate AC from supply

- **Filter**

if signal is limited to a frequency range, eg by bandpass noise filter

should be protected against noise outside range of interest

if insufficient, add more filtering